

FEATURES

- ❑ 800/825 kSPS sample rate
- ❑ 150mW power dissipation
- ❑ Military Temp Range -55°C to 125°C available
- ❑ Typical performance: 81.5dB S/(N + D) and 93dB THD
- ❑ No pipeline delays or missing codes
- ❑ Nap and shutdown modes
- ❑ Operates with 2.5V internal 15ppm/°C reference or external reference
- ❑ True differential inputs reject common mode noise
- ❑ 20MHz full-power bandwidth sampling
- ❑ Bipolar input range: $\pm 2.5V$
- ❑ Operational Environment; total dose irradiation testing to MIL-STD-883 Method 1019
 - Total-dose: 100 krad(Si)
 - Latchup immune ($LET \leq 60 \text{ MeV-cm}^2/\text{mg}$)
 - No destructive latchups above 60MeV-cm2/mg
- ❑ Class S A-to-D Converter built to your custom flow or from inventory

INTRODUCTION

Cobham RAD Solutions' (formerly Aeroflex RAD) RAD1419A Analog-to-Digital Converter (ADC) is a $1\mu s$, 800/825kSPS, 14-bit sampling A/D converter that draws only 150mW from $\pm 5V$ supplies. This easy-to-use device includes a high dynamic range sample-and-hold and a precision reference. Two digitally selectable power shutdown modes provide flexibility for low power systems.

The RAD1419A has a full-scale input range of $\pm 2.5V$. Outstanding AC performance includes 81.5dB S/(N + D) and 93dB THD with a 100kHz input; 80dB S/(N + D) and 86dB THD at the Nyquist input frequency of 400kHz.

The unique differential input sample-and-hold can acquire single-ended or differential input signals up to its 20MHz bandwidth. The 60dB common mode rejection allows users to eliminate ground loops and common mode noise by measuring signals differentially from the source.

The ADC has a μP compatible, 14-bit parallel output port. There is no pipeline delay in the conversion results. A separate convert start input and data ready signal (BUSY) ease connections to FIFOs, DPSs and microprocessors.

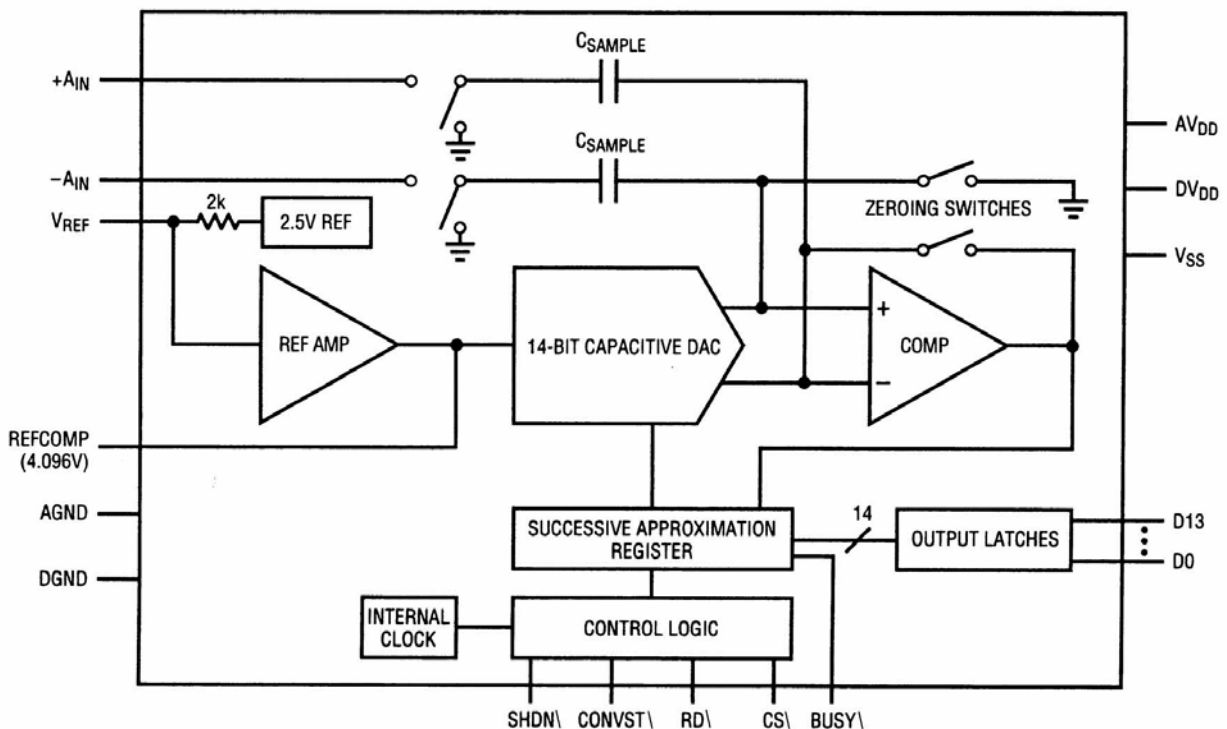

Figure 1. RAD1419A Block Diagram

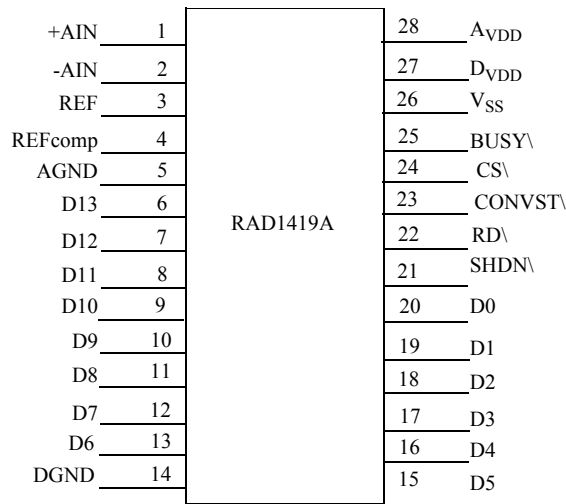

Figure 2. RAD1419A Pinout

PIN DESCRIPTION

Pin Name	No.	Description
+AIN	1	$\pm 2.5V$ Positive analog input
-AIN	2	$\pm 2.5V$ Negative analog input
VREF	3	2.5V Reference output. Bypass to AGND with 1 μ F.
REFcomp	4	4.06V Reference output. Bypass to AGND with 10 μ F tantalum in parallel with 0.1 μ F or 10 μ F ceramic.
AGND	5	Analog ground
D13 to D6	6-13	Three-state data outputs. The output format is 2's complement.
DGND	14	Digital ground for internal logic. Tie to AGND.
D5 to D0	0-5	Three-state data outputs. The output format is 2's complement.
SHDN\	21	Power shutdown input. Low selects shutdown. Shutdown mode selected by CS\ . CS\ = 0 nap mode and CS\ = 1 for sleep mode.
RD\	22	Read input. This enables the output drivers when CS\ is low.
CONVST\	23	Conversion start signal. This active low signal starts a conversion on its falling edge.
CS\	24	Chip select. The input must be low for the ADC to recognize CONVST\ and RD\ inputs. CS\ also sets the shutdown mode when SHDN\ goes low. CS\ and SHDN\ low select the quick wake-up nap mode. CS\ high and SHDN\ low select sleep mode.
BUSY\	25	The BUSY\ output shows the converter status. It is low when a conversion is in progress. Data valid on the rising edge of BUSY\.
VSS	26	5V Negative supply. Bypass to AGND with 10 μ F tantalum in parallel with 0.1 μ F or 10 μ F ceramic.
DVDD	27	5V Positive supply. Short to Pin 28.
AVDD	28	5V Positive Supply. Bypass to AGND with 10 μ F tantalum in parallel with 0.1 μ F or 10 μ F ceramic.

OPERATIONAL ENVIRONMENT

PARAMETER	LIMIT	UNITS
Total Ionizing Dose (TID)	1.0E5	rad(Si)
Single Event Latchup (SEL)	≤60	MeV-cm ² /mg
Neutron Fluence ¹	1.0E13	n/cm ²

Notes:

1. Guaranteed but not tested.

(Referenced to V_{SS})

ABSOLUTE MAXIMUM RATINGS¹

SYMBOL	PARAMETER	LIMITS
V _{DD}	Supply voltage	6.0V
V _{SS}	Negative supply voltage	-6.0V
V _{DD} to V _{SS}	Total supply voltage	12.0V
T _{STG}	Storage temperature	-65 to +150°C
P _D	Maximum power dissipation	500mW
T _J	Maximum junction temperature	150°C
R Θ _{JC}	Thermal resistance, junction-to-case ²	7.5°C/Watt
	Analog input voltage ³	V _{SS} -0.3V to V _{DD} +0.3V
	Digital input voltage ⁴	V _{SS} -0.3V to 10V

Notes:

1. Stresses outside the listed absolute maximum ratings may cause permanent damage to the device. This is a stress rating only, and functional operation of the device at these or any other conditions beyond limits indicated in the operational sections of this specification is not recommended. Exposure to absolute maximum rating conditions for extended periods may affect device reliability and performance.

2. Test per MIL-STD-883, Method 1012.

3. When these pin voltages are taken below V_{SS} or above V_{DD}, they will be clamped by internal diodes. This product can handle input currents greater than 100mA below V_{SS} or above V_{DD} without latchup.

4. When these pin voltages are taken below V_{SS}, they will be clamped by internal diodes. This product can handle input currents greater than 100mA below V_{SS} without latchup. These pins are not clamped to V_{DD}.

RECOMMENDED OPERATING CONDITIONS

SYMBOL	PARAMETER	LIMITS
V _{SS} to V _{DD}	Input/output voltage	-0.5V to +0.5V
T _C	Case temperature range	-55 to +125°C

ELECTRICAL CHARACTERISTICS

CONVERTER CHARACTERISTICS

*Denotes specifications which apply over the full operating temperature range, otherwise specifications are TA = +25°C. With Internal Reference.^{5,6}

SYMBOL	PARAMETER	CONDITIONS	MIL TEMP*	MIN	TYP	MAX	UNITS
	Resolution	(No Missing Codes)	X	14			Bits
INL	Integral Linearity Error	Note 7	X		±0.8	±2	LSB
DNL	Differential Linearity Error		X		±0.7	±1.5	LSB
					±0.7	±2	LSB
	Offset Error	Note 8	X		±5	±20	LSB
	Full scale Error Internal Reference				±10	±60	LSB
	Full scale Error External Reference	2.5V			±5		LSB
	Full Scale Tempco	I _{OUT} (REF) = 0			±15		ppm/°C

ANALOG INPUT

*Denotes specifications which apply over the full operating temperature range, otherwise specifications are TA = +25°C.⁵

SYMBOL	PARAMETER	CONDITIONS	MIL TEMP*	MIN	TYP	MAX	UNITS
V _{IN}	Analog Input Range	4.75V ≤ V _{DD} ≤ 5.25V, -5.25V ≤ V _{SS} ≤ -4.75V *	X		±2.5		V
I _{IN}	Analog Input Leakage Current	CS\ = HIGH	X			±1	μA
C _{IN}	Analog Input Capacitance	Between Conversions			15		pF
C _{IN}	Analog Input Capacitance	During Conversions			5		pF
t _{ACQ}	Sample-and-Hold Acquisition Time	Note 9*	X		90	300	ns
t _{AP}	Sample-and-Hold Aperture Delay Time				-1.5		ns
t _{JITTER}	Sample-and-Hold Aperture Delay Time Jitter				2		psRMS
CMRR	Analog Input Common Mode Rejection Ratio	-2.5V < (-AIN = AIN) < 2.5V			60		dB

DYNAMIC ACCURACY

*Denotes specifications which apply over the full operating temperature range, otherwise specifications are TA = +25°C.⁵

SYMBOL	PARAMETER	CONDITIONS	MIL TEMP*	MIN	TYP	MAX	UNITS
S/(N + D)	Signal-to (Noise + Distortion) Ratio	100 KHz Input Signal	X	78	81.5		dB
S/(N + D)	Signal-to (Noise + Distortion) Ratio	390 KHz Input Signal	X		80.0		dB
THD	Total Harmonic Distortion	100 KHz Input Signal, First 5 Harmonics	X		-93	-86	dB
THD	Total Harmonic Distortion	390 KHz Input Signal, First 5 Harmonics	X		-86		dB
SFDR	Spurious Free Dynamic Range	100 KHz Input Signal	X		-95	-86	dB
IMD	Intermodulation Distortion	f _{IN1} = 29.37 KHz, f _{IN2} = 32.446 KHz			-86		dB
	Full-Power Bandwidth				20		MHz
	Full-Linear Bandwidth	S/(N + D) ≥ 77dB			1		MHz

INTERNAL REFERENCE CHARACTERISTICS⁵

SYMBOL	PARAMETER	CONDITIONS	MIL TEMP*	MIN	TYP	MAX	UNITS
V _{REF}	Output Voltage	I _{OUT} = 0		2.480	2.500	2.520	V
V _{REF}	Output Tempco	I _{OUT} = 0			±15		ppm/°C
V _{REF}	Line Regulation	4.75V < V _{DD} < 5.25V, -5.25V < V _{SS} < -4.75V			0.05		LSB/V
V _{REF}	Output Resistance	-0.1mA < I _{OUT} < 0.1mA			2		kΩ
REFCOMP	Output Voltage	I _{OUT} = 0			4.06		V

DIGITAL INPUTS AND DIGITAL OUTPUTS

*Denotes specifications which apply over the full operating temperature range, otherwise specifications are TA = +25°C.⁵

SYMBOL	TEST	TEST CONDITION	MIL TEMP*	MIN	TYP	MAX	UNITS
V _{IH}	High Level Input Voltage	V _{DD} = 5.25V Note 12	X	2.4			V
V _{IL}	Low Level Input Voltage	V _{DD} = 4.75V Note 12	X			0.8	V
I _{IN}	Digital Input Current	V _{IN} = 0V to V _{DD}	X			±10	μA
C _{IN}	Digital Input Capacitance				5		pF
V _{OH}	High Level Output Voltage	V _{DD} = 4.75V IO = -10μA*	X		4.5		V
V _{OH}	High Level Output Voltage	V _{DD} = 4.75V IO = -200μA	X	4.0			V
V _{OL}	Low Level Output Voltage	V _{DD} = 4.75V IO = 160μA	X		0.05		V
V _{OL}	Low Level Output Voltage	V _{DD} = 4.75V IO = 1.6mA *	X		0.10	0.4	V
I _{OZ}	High-Z Output Leakage D13 to D0	V _{OUT} = 0V to V _{DD} , CS\ High *	X			±10	μA
C _{OZ}	High-Z Output Capacitance D13 to D0	CS\ High, Note 9 *	X			15	pF
I _{SOURCE}	Output Source Current	V _{OUT} = 0V			-10		mA
I _{SINK}	Output Sink Current	V _{OUT} = V _{DD}			10		mA

POWER REQUIREMENTS

*Denotes specifications which apply over the full operating temperature range, otherwise specifications are TA = +25°C.⁵

SYMBOL	PARAMETER	CONDITIONS	MIL TEMP*	MIN	TYP	MAX	UNITS
V _{DD}	Positive Supply Voltage	Note 10		4.75		5.25	V
V _{SS}	Negative Supply Voltage	Note 10		-4.75		-5.25	V
I _{DD}	Positive Supply Current		X		11	20	mA
I _{DD}	Positive Supply Current	Nap Mode: SHDN\ = 0V, CS\ = 0V	X		1.5		mA
I _{DD}	Positive Supply Current	Sleep Mode: SHDN\ = 0V, CS\ = 5V	X		250		μA
I _{SS}	Negative Supply Current		X		19	30	mA
I _{SS}	Negative Supply Current	Nap Mode: SHDN\ = 0V, CS\ = 0V	X		100		μA
I _{SS}	Negative Supply Current	Sleep Mode: SHDN\ = 0V, CS\ = 5V	X		1		μA
P _{DIS}	Power Dissipation		X		150	240	mW
P _{DIS}	Power Dissipation	Nap Mode: SHDN\ = 0V, CS\ = 0V	X		7.5	1.2	mW
P _{DIS}	Power Dissipation	Sleep Mode: SHDN\ = 0V, CS\ = 5V	X		1.2		mW

TIMING CHARACTERISTICS (Cont'd)

*Denotes specifications which apply over the full operating temperature range, otherwise specifications are TA = +25°C.⁵

SYMBOL	PARAMETER	CONDITIONS	MIL TEMP*	MIN	TYP	MAX	UNITS
RD\ Low Time	t ₁₂	Note 9	X	10			ns
CONVST\ High Time	t ₁₃	Note 9	X	40			ns

Notes:

Parameters listed only as "Typical" are not tested in production.

1. Absolute Maximum Ratings are those values beyond which the life of a device may be impaired.
2. All voltage values are with respect to ground with D_{GND} and A_{GND} wired together unless otherwise noted.
3. When these pin voltages are taken below V_{SS} or above V_{DD}, they will be clamped by internal diodes. This product can handle input currents greater than 100mA below V_{SS} or above V_{DD} without latch up.
4. When these pin voltages are taken below V_{SS}, they will be clamped by internal diodes. This product can handle input currents greater than 100mA below V_{SS} without latch up. These pins are not clamped to V_{DD}.
5. V_{DD} = 5V, V_{SS} = -5V, f_{SAMPLE} = 800kHz, tr = tf = 5ns unless otherwise specified.
6. Linearity, offset and full-scale specifications apply for a single ended +A_{IN} input with - A_{IN} grounded.
7. Integral nonlinearity is defined as the deviation of a code from a straight line passing through the actual endpoints of the transfer curve. The deviation is measured from the center of the quantization band.
8. Bipolar offset is the offset voltage measured from -0.5LSB when the output code flickers between 0000 0000 0000 00 and 1111 1111 1111 11.
9. Guaranteed by design or characterization, not subject to test in production.
10. Recommended operating conditions.
11. The falling edge of CONVST\ starts a conversion. If CONVST\ returns high at a critical point during the conversion it can create small errors. For best performance ensure that CONVST\ returns high either within 650ns after the start of the conversion or after BUSY rises.
12. V_{IH} and V_{IL} will be guaranteed by testing V_{OH} and V_{OL} at the appropriate levels.

S/(N+D) vs Input Frequency and Amplitude

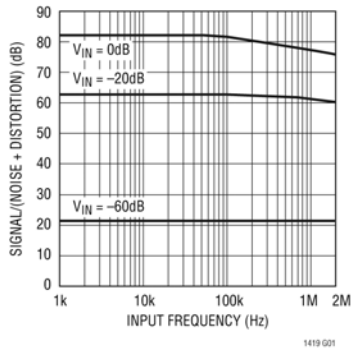

Signal-to-Noise Ratio

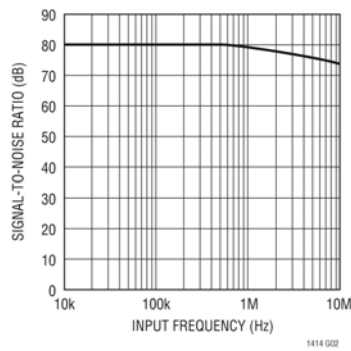

Distortion vs Input Frequency

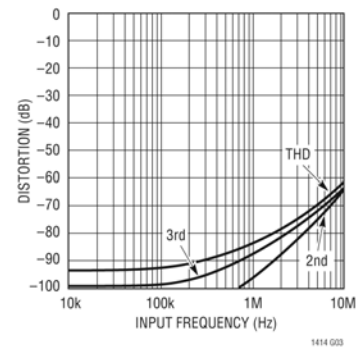

Spurious-Free Dynamic Range vs Input Frequency

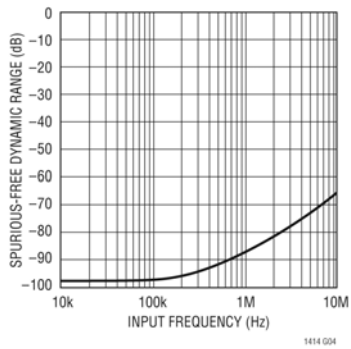

Intermodulation Distortion Plot

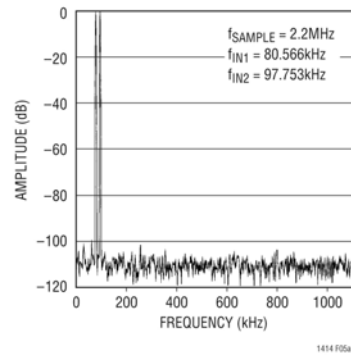

Differential Nonlinearity vs Output Code

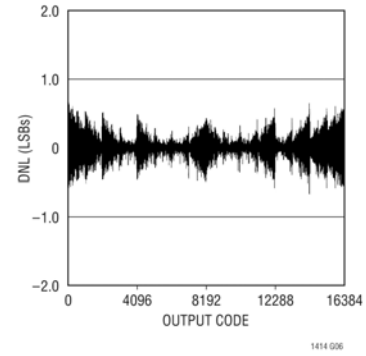

Integral Nonlinearity vs Output Code

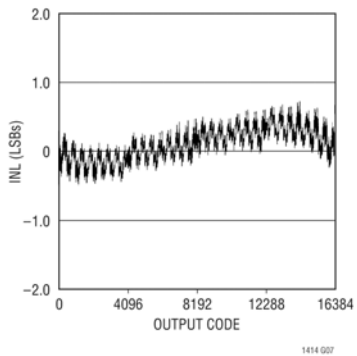

Power Supply Feedthrough vs Ripple Frequency

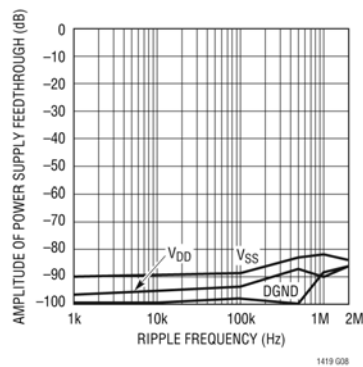

Input Common Mode Rejection vs Input Frequency

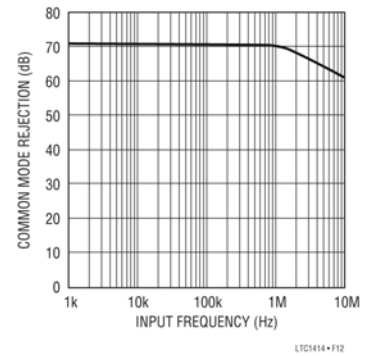

Figure 2. Typical Performance Characteristics

ORDERING INFORMATION

RAD1419A: Please see the RAD1419A SCD for order information.

Cobham RAD Solutions - Datasheet Definition

Datasheet - Class S Compliant

The following United States (U.S.) Department of Commerce statement shall be applicable if these commodities, technology, or software are exported from the U.S.: These commodities, technology, or software were exported from the United States in accordance with the Export Administration Regulations. Diversion contrary to U.S. law is prohibited.

Aeroflex RAD Inc, dba Cobham RAD Solutions
5030 Centennial Blvd
Colorado Springs, CO 80907

COBHAM

E: info-ams@cobham.com
T: 719-531-0800

Aeroflex RAD, Inc.Inc., dba Cobham RAD Solutions, reserves the right to make changes to any products and services described herein at any time without notice. Consult Aeroflex or an authorized sales representative to verify that the information in this data sheet is current before using this product. Aeroflex does not assume any responsibility or liability arising out of the application or use of any product or service described herein, except as expressly agreed to in writing by Aeroflex; nor does the purchase, lease, or use of a product or service from Aeroflex convey a license under any patent rights, copyrights, trademark rights, or any other of the intellectual rights of Aeroflex or of third parties.