

UT8SF2M32 64Megabit Flow-thru SSRAM

April 2015



FEATURES

- ❑ Synchronous SRAM organized as 2Meg words x 32bit
- ❑ Continuous Data Transfer (CDT) architecture eliminates wait states between read and write operations
- ❑ Supports 40MHz to 80MHz bus operations
- ❑ Internally self-timed output buffer control eliminates the need for synchronous output enable
- ❑ Registered inputs for flow-thru operations
- ❑ Single 2.5V to 3.3V supply
- ❑ Clock-to-output times
 - Clk to Q = 12ns
- ❑ Clock Enable ($\overline{\text{CEN}}$) pin to enable clock and suspend operation
- ❑ Synchronous self-timed writes
- ❑ Three Chip Enables ($\overline{\text{CS0}}$, CS1, $\overline{\text{CS2}}$) for simple depth expansion
- ❑ "ZZ" Sleep Mode option for partial power-down
- ❑ "SHUTDOWN" Mode option for deep power-down
- ❑ Four Word Burst Capability--linear or interleaved
- ❑ Operational Environment
 - Total Dose: 100 krad(Si)
 - SEL Immune: $\leq 100\text{MeV}\cdot\text{cm}^2/\text{mg}$
 - SEU error rate: 1×10^{-15} errors/bit-day with internal error correction
- ❑ Package options:
 - 288-lead CLGA, CCGA, and CBGA
- ❑ Standard Microelectronics Drawing (SMD) 5962-15214
 - QMLQ and Q+ pending

INTRODUCTION

The UT8SF2M32 is a high performance 67,108,864-bit synchronous static random access memory (SSRAM) device that is organized as 2M words of 32 bits. This device is equipped with three chip selects ($\overline{\text{CS0}}$, CS1, and $\overline{\text{CS2}}$), a write enable ($\overline{\text{WE}}$), and an output enable ($\overline{\text{OE}}$) pin, allowing for significant design flexibility without bus contention. The device supports a four word burst function using ($\text{ADV}_{\overline{\text{LD}}}$). The device achieves a very low error rate by employing SECDED (single error correction double error detection) EDAC (error detection and correction) scheme during read/write operations as well as additional autonomous data scrubbing. The data scrubbing is performed in the background and is invisible to the user.

All synchronous inputs are registered on the rising edge of the clock provided the Clock Enable ($\overline{\text{CEN}}$) input is enabled LOW. Operations are suspended when $\overline{\text{CEN}}$ is disabled HIGH and the previous operation is extended. Write operation control signals are $\overline{\text{WE}}$ and FLSH_PIPE. All write operations are performed by internal self-timed circuitry.

For easy bank selection, three synchronous Chip Enables ($\overline{\text{CS0}}$, CS1, $\overline{\text{CS2}}$) and an asynchronous Output Enable ($\overline{\text{OE}}$) provide for output tri-state control. The output drivers are synchronously tri-stated during the data portion of a write sequence to avoid bus contention.

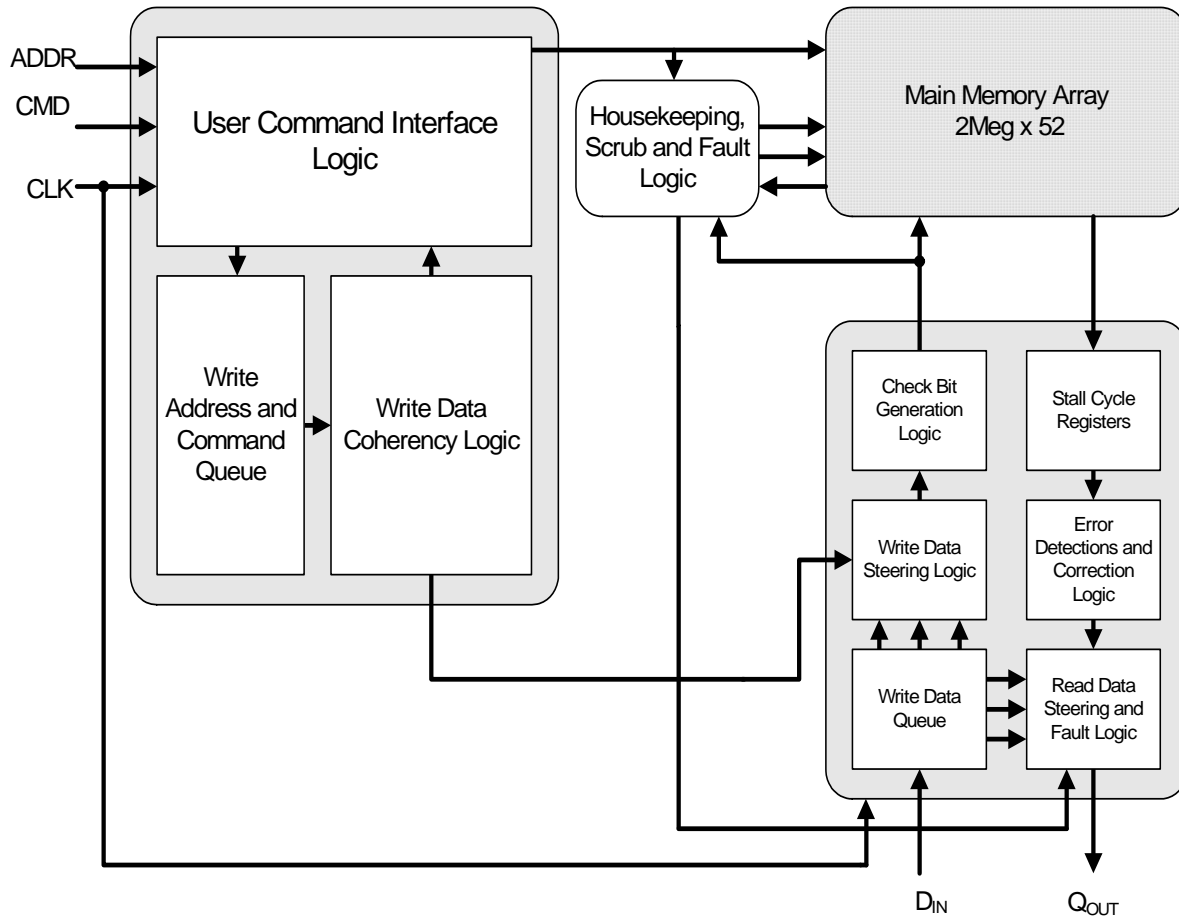

Figure 1. UT8SF2M32 Block Diagram

Table 1: Pin Definitions

NAME	DESCRIPTION	TYPE
$\overline{CS0}$	Chip Enable 0, Input, Active LOW: Sampled on the rising edge of CLK. Used in conjunction with CS1 and $\overline{CS2}$ to select or deselect the device.	Input-Synchronous
CS1	Chip Enable 1 Input, Active HIGH: Sampled on the rising edge of CLK. Used in conjunction with $\overline{CS0}$ and $\overline{CS2}$ to select or deselect the device.	Input-Synchronous
$\overline{CS2}$	Chip Enable 2 Input, Active LOW: Sampled on the rising edge of CLK. Used in conjunction with $\overline{CS0}$ and CS1 to select or deselect the device.	Input-Synchronous
A[20:0]	Address Inputs: Sampled at the rising edge of the CLK. A[1:0] is fed to the two-bit burst counter.	Input-Synchronous
FLSH_PIPE	Flush Pipeline Input, Active HIGH: Qualified with \overline{WE} to conduct dummy writes to flush pipeline. Must be LOW during normal write operation.	Input-Synchronous
\overline{WE}	Write Enable Input, Active LOW: Sampled on the rising edge of CLK if \overline{CEN} is active LOW. This signal must be enabled LOW to initiate a write sequence.	Input-Synchronous
ADV_ \overline{LD}	Advance/Load Input: Advances the on-chip address counter or loads a new address. When HIGH (and \overline{CEN} is enabled LOW) the internal burst counter is advanced. When LOW, a new address can be loaded into the device for an access. After deselection, drive ADV_ \overline{LD} LOW to load a new address.	Input-Synchronous
CLK	Clock Input: Used to capture all synchronous inputs to the device. CLK is qualified with \overline{CEN} . CLK is only recognized if \overline{CEN} is active LOW.	Input-Clock
\overline{OE}	Output Enable, Asynchronous Input, Active LOW: Combined with the synchronous logic block inside the device to control the direction of the I/O pins. When LOW, the I/O pins are enabled to behave as outputs. When disabled HIGH, I/O pins are tri-stated, and act as input data pins. \overline{OE} is masked during the data portion of a write sequence, during the first clock when emerging from a deselected state and when the device is deselected.	Input-Asynchronous
\overline{CEN}	Clock Enable Input, Active LOW: When enabled LOW, the clock signal is recognized by the SSRAM. When deasserted HIGH, the clock signal is masked. Because deasserting \overline{CEN} does not deselect the device, \overline{CEN} can be used to extend the previous cycle when required.	Input-Synchronous
DQ[51:0] ¹	Bidirectional Data I/Os: As inputs, DQ[51:0] feed into an on-chip data register that is triggered by the rising edge of CLK. As outputs, DQ[51:0] delivers the data contained in the memory location specified by the addresses presented during the previous clock rise of the read cycle. The direction of the pins is controlled by \overline{OE} . When \overline{OE} is enabled LOW, the pins behave as outputs. When HIGH, DQs are placed in a tri-state condition. The outputs are automatically tri-stated during the data portion of a write sequence, during the first clock when emerging from a deselected state, and when the device is deselected, regardless of the state of \overline{OE} . Aeroflex recommends connecting all DQ pins to either V_{DDQ} or V_{SS} through a $\geq 10k\Omega$ resistor.	I/O-Synchronous
\overline{RESET}	Reset Input, Active Low: Resets device to known configuration. Reset is required at initial power-up after exiting shutdown mode, or after any power interruption.	Input-Asynchronous

Table 1: Pin Definitions

NAME	DESCRIPTION	TYPE
ZZ	ZZ “Sleep” Input, Active HIGH: When HIGH, places the device in a non-time critical “sleep” condition with data integrity preserved. During normal operation, this pin must be LOW.	Input-Synchronous
SHUTDOWN	Shutdown Input, Active HIGH: When HIGH, places device in shutdown mode. System clock can be stopped. Memory contents are not retained.	Input-Asynchronous
READY ²	Device Ready Output: READY outputs a HIGH when device is available for normal operations. READY outputs a LOW when requesting an idle cycle or during power up initialization.	Output-Synchronous
MBE0 MBE1 MBEC	Multiple Bit Error Flags: When LOW data is valid, when HIGH data is corrupt. Users can monitor either MBE0 and MBE1 or MBEC (combined).	Output-Synchronous
MODE ³	Mode Input: Established at power up. Selects the burst order of the device. When tied to V _{SS} selects linear burst sequence. When tied to V _{DDQ} selects interleaved burst sequence.	Input-DC
EDACEN	EDAC Enable Input: EDAC is enabled when HIGH. When LOW, allows for simple package pin disable of EDAC. Device pin internally connected through a 75kΩ±10% resistor to V _{DDQ} .	Input-DC
SCRUBEN	SCRUB Enable Input: Scrub mode is enabled when HIGH. When LOW, scrub mode is externally disabled. Device pin internally connected through 1 75kΩ±10% resistor to V _{DDQ} .	Input-DC
EXTRES ³	Input Current Reference: Provided for external precision current reference resistor connection.	Input-DC
V _{DD}	Power Supply Inputs to the Core of the Device.	Power Supply
V _{DDQ}	Power Supply for the I/O Circuitry.	I/O Power Supply
V _{SS}	Ground inputs to the core of the device.	Ground
V _{SSQ}	Ground for I/O circuitry	I/O ground

NUIL	Not used Input Low: Pins designated as NUIL need to be externally connected by user to V_{SSQ} through a $\geq 10k\Omega \pm 10\%$ resistor.	--
NUIH	Not used Input High: Pins designated as NUIH need to be externally connected by user to V_{DDQ} through a $\geq 10k\Omega \pm 10\%$ resistor.	--
NC	No Connects. Not internally connected to the die.	---
TDO ⁴	JTAG circuit serial data output. Package pin requires a pull-up through $\geq 10k\Omega \pm 10\%$ resistor to V_{DDQ} .	JTAG Serial Output Synchronous
TDI ⁴	JTAG circuit serial data input. Device pin internally connected through a $75k\Omega \pm 10\%$ resistor to V_{DDQ} .	JTAG Serial Input Synchronous
TMS ⁴	JTAG controller Test Mode Select. Device pin internally connected through a $75k\Omega \pm 10\%$ resistor to V_{DDQ} .	Test Mode Select Synchronous
TCK ⁴	JTAG circuit Clock input. Package pin requires a pull-up through $\geq 10k\Omega \pm 10\%$ resistor to V_{DDQ} .	JTAG Clock

Note:

1. DQ[51:32] are ignore during write and tri-stated during read activities unless EDACEN is deselected. (See Read Access Error Correction and Detection page 6.)
2. Reference application note AN-MEM-004 for additional READY signal information.
3. DC inputs are established at power up and cannot be switched while power is applied to the device.
4. Reference application note AN-MEM-05 for JTAG operations. JTAG operations are intended for terrestrial use and not guaranteed in radiation environment.

DEVICE OPERATION

The UT8SF2M32 is synchronous flow-thru SSRAM designed specifically to eliminate wait states during Write/Read or Read/Write transitions. All synchronous inputs are registered on the rising edge of clock. The clock signal is enabled by the Clock Enable input ($\overline{\text{CEN}}$). When $\overline{\text{CEN}}$ is HIGH, the clock signal is disregarded and all internal states are maintained. All synchronous operations are qualified by $\overline{\text{CEN}}$. Once power-up requirements have been satisfied, the input clock may only be stopped during sleep (ZZ is HIGH) or shutdown mode (SHUTDOWN is HIGH). Maximum access delay from the rising edge of clock (t_{CQV}) is 11.5ns (80MHz device).

Access is initiated by asserting all three Chip Enables ($\overline{\text{CS0}}$, CS1, $\overline{\text{CS2}}$) active at the rising edge of the clock with Clock Enable ($\overline{\text{CEN}}$) and ADV_LD asserted LOW. The address presented to the device will be registered. Access can be either a Read or Write operation, depending on the status of the Write Enable ($\overline{\text{WE}}$).

Write operations are initiated by the Write Enable ($\overline{\text{WE}}$) input. All write commands are controlled by built in synchronous self-timed circuitry.

Three synchronous Chip Enables ($\overline{\text{CS0}}$, CS1, $\overline{\text{CS2}}$) and an asynchronous Output Enable ($\overline{\text{OE}}$) simplify memory depth expansion. All operations (Reads, Writes, and Deselects) are registered. ADV_LD must be driven LOW once the device has been deselected in order to load a new address and command for the next operation.

Single Read Accesses

A read access is initiated when the following device inputs are present at rising clock edge: $\overline{\text{CEN}}$ is enabled LOW, $\overline{\text{CS0}}$, CS1, and $\overline{\text{CS2}}$ are all enabled, the Write Enable input signal $\overline{\text{WE}}$ is disabled HIGH and ADV_LD is asserted LOW. The addresses present at the address inputs A[20:0] are registered and presented to the memory. Data is available to the bus within 12ns provided $\overline{\text{OE}}$ is enabled LOW. After the first clock of the read access, the output buffers are controlled by $\overline{\text{OE}}$ and the internal control logic. $\overline{\text{OE}}$ must be enabled LOW to drive requested data. During the next rising clock, any operation (Read/Write/Deselect) may be initiated.

Burst Read Accesses

The UT8SF2M32 has an internal burst counter allowing up to four reads to be performed from a single address input. A new address can only be loaded when ADV_LD is driven LOW. New addresses are loaded into the SSRAM, as described by the Single Read Access section. The burst counter operates in either linear or interleave and is controlled by the MODE input

at power up. When MODE pin is LOW, the burst sequence is linear. The burst sequence is interleaved when MODE is HIGH. A0 and A1 are controlled by the burst counter. Burst counter will wrap around when needed. The burst counter increments anytime ADV_LD is HIGH and $\overline{\text{CEN}}$ is LOW. The operation selected by the state of $\overline{\text{WE}}$ is latched at the beginning of the sequence and maintained throughout.

Read Access Error Detection and Correction

The UT8SF2M32 device features an embedded single error correction double error detection (SECDED) Aeroflex proprietary error correction scheme. Single bit errors are corrected during read accesses. Data corrections, to the core memory, occurs during a separate data scrubbing activities. Double bit errors are detected and indicated by MBE0, MBE1 and MBEC. The MBE0 output is the multibit error indicator for the 16 even DQs. The MBE1 output is the multibit error indicator for 16 odd DQs. MBEC is the combined ORed result of MBE0 and MBE1. Either MBEC or MBE0 and MBE1 can be monitored to validate data. If all MBEx signals (MBEC, MBE0, MBE1) remain LOW during a data output cycle, the data is valid. If any of the MBE signal pins go active HIGH during a read activity, the data is invalid and contains an uncorrectable multibit error. Aeroflex recommends that all DQ pins be connected to either V_{DDQ} or V_{SSQ} through pull up/down resistors as DQ[51:0] must not be left floating. The upper 20 I/O pins DQ[51:32] are used for error code data storage, and need to be individually connected to soft pull ups or downs (refer to Table 4 external connections). When the EDAC is enabled via the EDACEN pin, the upper 20 data I/Os are ignored during write operations and tri-stated during read operations. When the EDAC is disabled, the upper 20 data I/Os may be written and read the same as DQ[31:0].

Single Write Accesses

A write access is initiated when the following device inputs are present at rising clock edge: $\overline{\text{CEN}}$ is enabled LOW, $\overline{\text{CS0}}$, CS1, and $\overline{\text{CS2}}$ are all enabled, the Write Enable input signal $\overline{\text{WE}}$, ADV_LD , and FLSH_PIPE are asserted LOW. The addresses present at the address inputs A[20:0] are registered and presented to the memory core. Data I/Os are tri-stated after t_{CQZ} is satisfied regardless of the state of $\overline{\text{OE}}$.

During a write operation, data is qualified by the FLSH_PIPE input. Input data at DQ[51:0] is registered when FLSH_PIPE is LOW in conjunction with an active $\overline{\text{WE}}$, but ignored when FLSH_PIPE is HIGH with an active $\overline{\text{WE}}$. In either state of FLSH_PIPE , commands are shifted through the register pipeline.

To avoid bus contention data should not be driven to DQs when outputs are active. The Output Enable (\overline{OE}) may be disabled HIGH before applying data to the DQ lines. This will tri-state the DQ output drivers. As an additional feature DQ lines are automatically tri-stated during the data portion of a Write cycle, regardless of the state of \overline{OE} .

Burst Write Accesses

The UT8SF2M32 has an internal burst counter allowing up to four writes to be performed from a single address input. A new address can only be loaded when $\overline{ADV_LD}$ is driven LOW. New addresses are loaded into the SSRAM, as described the Single Write Access section. When $\overline{ADV_LD}$ is driven HIGH where \overline{CEN} is LOW on the subsequent clock rise, the Chip Enables ($\overline{CS0}$, CS1, $\overline{CS2}$) and \overline{WE} inputs are ignored and the burst counter is incremented. The FLSH_PIPE input must be LOW in each cycle of the burst write in order to write the correct data.

READY Status

The UT8SF2M32 device operates as a Synchronous SRAM device. Data integrity housekeeping activities are performed in the background during normal user activity. These housekeeping activities are performed on a regular basis. However, when a housekeeping activity sequence cannot be completed due to user conflict for memory space, the READY pin asserts signifying to the user that an idle cycle is required. Please reference applications note AN-MEM-004 for more information.

Data Scrubbing

The UT8SF2M32 device employs internal autonomous data scrubbing. The scrub circuit cycles through all address spaces typically once every 0.5 seconds. Scrub cycles occur anytime power is applied provided SCRUBEN is HIGH. When the EDAC circuit is disabled via EDACEN input LOW, DQ[51:32] pins are available for read and write accesses. However if the SCRUBEN is not also disabled, data written to DQ[51:32] could be changed by the internal data scrubbing activity.

FLSH_PIPE

The write operation consists of two register stages. Writing data to the core memory requires three subsequent write operations. Dummy write operations can be performed using the FLSH_PIPE inputs. Because data coherency is always maintained and the SEU error rate includes the pipeline registers, flushing the pipeline is not necessary.

Sleep Mode

The ZZ input lead is a synchronous input. Asserting the ZZ pin HIGH places the SSRAM into a power conservative "sleep" mode. To assure the completion of previous commands through the pipeline prior to entering sleep mode, a minimum of two full clock cycles (t_{ZZS}) are required between the last operation command and asserting the ZZ input. While in sleep mode, data integrity is guaranteed. Changing the input clock frequency or halting the input clock may be executed during sleep mode. The device must be deselected prior to entering sleep mode and remain deselected for the duration of t_{ZZREC} after the ZZ input returns LOW.

Shutdown Mode

The SHUTDOWN input pin is an asynchronous input. Asserting SHUTDOWN places the device in a power saving shutdown mode. The system clock can be stopped. Memory contents are not maintained in shutdown mode. The SSRAM requires a reset upon exiting shutdown mode.

**Table 2. Linear Burst Address Table
(MODE=V_{SS})**

Starting Address	Second Address	Third Address	Fourth Address
A1, A0	A1, A0	A1, A0	A1, A0
00	01	10	11
01	10	11	00
10	11	00	01
11	00	01	10

**Table 3. Interleaved Burst Address Table
(MODE=V_{DDQ})**

Starting Address	Second Address	Third Address	Fourth Address
A1, A0	A1, A0	A1, A0	A1, A0
00	01	10	11
01	00	11	10
10	11	00	01
11	10	01	00

Power Up/ Down Requirements

The SSRAM requires that $V_{DD} \leq V_{DDQ}$ at all times. The SSRAM does require the user to provide an external reset after initial power application, exiting shutdown mode, or any power interruption to the device input voltage outside the specified limit. Performing a reset requires the assertion of the /RESET device input lead (LOW) for a minimum of 1us (t_{RLRH}). After the /RESET input is returned HIGH, the device requires 50us ($t_{SHTDWNREC}$) to complete the reset operation. Once the reset operation is complete, the device requires an additional 20us (t_{CR}) to synchronize the clock input providing a stable input clock is present. The device READY output lead asserts HIGH once t_{CR} is satisfied at the next rising clock. The READY out lead HIGH indicates the device is available for normal operations. For power down it is required that V_{DD} and V_{DDQ} be powered down to $\leq 0.5V$ for a minimum of 100ms.

Clock Conditioning Requirements

The CLK signal input requirements are given in the Clock section of the AC Characterizations. AC Characterization performances listed herein are based on providing a clock input signal meeting these requirements.

Changing Clock Frequencies

The CLK input frequency should be established at power on, and may only be changed while in SLEEP mode (reference Table 5).

External Connections

A precision 25kohm $\leq \pm 0.2\%$ low TCR $\leq 25\text{ppm}/^\circ\text{C}$ resistor is required to be connected between device pin EXTRES (R15) and V_{SS} .

In order to ensure proper operation in conjunction with JTAG boundary (reference applications note MEM-AN-005) and EDAC bypass capabilities, Aeroflex requires that specific package pins be biased through soft connections to either V_{DD} , V_{DDQ} or V_{SS} . Table 4 below is a list of these required external biases.

Table 4. External Bias Conditions

Signal Name	Package Pin	Bias Condition
NUIL ¹	P13, R7, R8, R12, R13, R14, R16	$\geq 10k\Omega$ to V_{SSQ}
NUIH ²	P16	$\geq 10k\Omega$ to V_{DDQ}
TDO	R5	$\geq 10k\Omega$ to V_{DDQ}
TCK	R9	$\geq 10k\Omega$ to V_{SSQ}
DQ[51:0] ⁴	ref Table 6	$\geq 10k\Omega$ to V_{DDQ} or V_{SSQ}

Notes:

1. NUIL = Not Used Input Low
2. NUIH = Not Used Input High
3. Aeroflex recommends connecting all DQ[51:0] to either V_{DDQ} or V_{SS} through $\geq 10k\Omega$ resistors.

Table 5: Truth Table for UT8SF2M32 [1,2,3,4,5,6,7]

Operation	Address Used	$\overline{\text{CSx}}^*$	ZZ	SHUT DOWN	ADV_LD	$\overline{\text{WE}}$	FLSH_PIPE	$\overline{\text{OE}}$	$\overline{\text{CEN}}$	CLK	DQs
Standby Mode	None	H	L	L	L	X	X	X	L	L-H	3-State
Continue Deselect	None	X	L	L	H	X	X	X	L	L-H	3-State
Read Cycle (Start Burst)	External	L	L	L	L	H	X	L	L	L-H	Data Out
Read Cycle (Cont. Burst)	Next	X	L	L	H	X	X	L	L	L-H	Data Out
NOP/Dummy Read (Start)	External	L	L	L	L	H	X	H	L	L-H	3-State
NOP/Dummy Read (Cont.)	Next	X	L	L	H	X	X	H	L	L-H	3-State
Write Cycle (Start Burst)	External	L	L	L	L	L	L	X	L	L-H	Data In
Write Cycle (Cont. Burst)	Next	X	L	L	H	X	L	X	L	L-H	Data In
Dummy Write (Start)	None	L	L	L	L	L	H	X	L	L-H	3-State
Dummy Write (Cont. Burst)	Next	X	L	L	H	X	H	X	L	L-H	3-State
Clock Inhibit (Stall)	N/A	X	L	L	X	X	X	X	H	L-H	N/A
Sleep Mode	N/A	H	H	L	X	X	X	X	X	X	3-State
Shutdown Mode	None	X	X	H	X	X	X	X	X	X	3-State

Notes:

- * All chip selects active when L, at least one chip select inactive when H
- 1. X = "Don't Care", H = Logic HIGH, L = Logic LOW
- 2. Write is defined by $\overline{\text{WE}}$ and FLSH_PIPE.
- 3. When a Write cycle is detected, all I/Os are tri-stated.
- 4. The DQ pins are controlled by the current cycle and the $\overline{\text{OE}}$ signal.
- 5. $\overline{\text{CEN}} = \text{H}$ inserts wait states.
- 6. Device will power-up deselected and the I/Os in a tri-state condition, regardless of $\overline{\text{OE}}$.
- 7. $\overline{\text{OE}}$ is asynchronous and is not sampled with the clock rise. It is masked internally during Write cycles. During a Read cycle DQs = tri-state when $\overline{\text{OE}}$ is inactive or when the device is deselected and DQs = data when $\overline{\text{OE}}$ is active.

Table 6. 288-Lead Flow-thru Signal Locations

	1	2	3	4	5	6	7	8	9	10	11	12	13	14	15	16	17	18	19	20
A			VDDQ	$\overline{\text{CS2}}$	$\overline{\text{WE}}$	VSS	A10	A8	A4	A18	A19	A14	A15	A2	A0	$\overline{\text{CS0}}$	VSS	VSS		
B		VSS	VSS	$\overline{\text{OE}}$	VSS	A11	A9	A6	A17	VSS	A20	A16	A13	A12	A1	ZZ	VSS	SHUT DOWN	VSS	
C	VDDQ	VSSQ	VSS	READY	FLSH_ PIPE	VSS	A7	A5	VSS	VDD	VSS	VSSQ	VDD	VDD	A3	$\overline{\text{ADV_LD}}$	CS1	VSS	VSSQ	VDD
D	DQ33	DQ35	VDD	VSS	VSS	VDDQ	VSSQ	VDD	VDD	VSS	VDD	VDD	VSSQ	VDDQ	VDD	VSS	VSS	VDD	VDDQ	DQ32
E	DQ37	DQ1	DQ39	VDD	VSSQ	VSS	VSSQ	VDDQ	VSS	VSS	VSS	VSSQ	VDDQ	VSS	VSS	VSSQ	VDD	DQ38	DQ36	DQ34
F	DQ3	DQ5	DQ7	VDDQ	VDDQ	VSSQ	VSS	VSS	VDD	VSS	VDD	VSS	VSS	VDDQ	VSSQ	VDDQ	VDDQ	DQ4	DQ0	DQ2
G	DQ9	DQ11	DQ13	VDD	VSSQ	VDD	VDDQ	VDD	VSS	VDD	VSS	VDD	VDDQ	VSSQ	VDD	VSSQ	VDD	DQ10	DQ6	DQ8
H	MBE1	DQ15	$\overline{\text{CEN}}$	VSS	VSS	VDD	VDD	VDD	VSS	VSS	VSS	VDD	VDD	VSS	VSS	VSS	VSS	CLK	DQ12	MBE0
J	DQ19	DQ17	DQ21	VDD	VSSQ	VDD	VSS	VDD	VSS	VDD	VSS	VDD	VSS	VSSQ	VDD	VSSQ	VDD	DQ14	DQ16	DQ18
K	DQ27	DQ25	DQ23	VDDQ	VDDQ	VSSQ	VSS	VDDQ	VDD	VSS	VDD	VDDQ	VSS	VDDQ	VSSQ	VDDQ	VDDQ	DQ20	DQ24	DQ22
L	DQ31	DQ41	DQ29	VDD	VSSQ	VSS	VSSQ	VDDQ	VSS	VSS	VSS	VSSQ	VDDQ	VSS	VSS	VSSQ	VDD	DQ26	DQ30	DQ28
M	DQ45	DQ47	DQ43	VDD	VSS	VSSQ	VDDQ	VSSQ	VDD	VSS	VDD	VDD	VSSQ	VDDQ	VSSQ	VSS	VDD	DQ40	DQ44	DQ42
N	DQ51	DQ49	VSS	VSS	VDD	VDDQ	VSSQ	VDD	VSS	VDD	VSS	VSS	VDD	VSSQ	VSSQ	VDD	VSS	DQ46	DQ48	DQ50
P		VSS	VSS	VDD	SCRUB EN	VSSQ	VSSQ	VSSQ	VSS	VSS	VDDQ	MODE	NUIL ³	EDACEN	TMS	NUIH ⁴	VSSQ	VSS	VSS	
R			VDD	TDI	TDO ¹	VDD	NUIL ³	NUIL ³	TCK ²	MBEC	$\overline{\text{RESET}}$	NUIL ³	NUIL ³	NUIL ³	EXTRES	NUIL ³	VDDQ	VDD		

Notes:

1. Pin requires pull-up to V_{DDQ} of $\geq 10k\Omega \pm 10\%$.
2. Pin requires pull-down to V_{SS} of $\geq 10k\Omega \pm 10\%$.
3. NUIL = Not used Input Low. NUIL pins requires $\geq 10k\Omega \pm 10\%$ pull-down to V_{SSQ} .
4. NUIH = Not Used Input High. NUIH pins requires $\geq 10k\Omega \pm 10\%$ pull-up to V_{DDQ} .

ABSOLUTE MAXIMUM RATINGS¹

(Referenced to V_{SS})

SYMBOL	PARAMETER	VALUE	UNIT
V _{DD} /V _{DDQ}	Supply Voltage ²	-0.5 to 4.0	V
V _{IN}	Voltage on any pin ²	-0.3 to V _{DDQ} +0.3	V
I _{IO}	DC I/O current per pin @ T _J = 135° for 15 years	±10	mA
P _D	Package power dissipation permitted @ T _C = 105°C ³	15	W
T _J	Maximum junction temperature	+150	°C
Θ _{JC}	Thermal resistance junction to case	3	°C/W
T _{STG}	Storage temperature	-65 to +150	°C

Notes:

1. Permanent device damage may occur if absolute maximum ratings are exceeded. Functional operation should be restricted to recommended operating conditions.
2. All voltages are referenced to V_{SS}.
3. Per MIL-STD-883, Method 1012, Section 3.4.1 $P_D = \frac{(T_J(\max) - T_C(\max))}{\Theta_{JC}}$

OPERATIONAL ENVIRONMENTS¹

PARAMETER	LIMIT	UNITS
Total Ionizing Dose (TID)	100K	rad(Si)
Heavy Ion Error Rate	1x10 ⁻¹⁵	Errors/Bit-Day
Single Event Latchup (SEL) immune ²	≤ 100	MeV-cm ² /mg

Notes:

1. Adams 90% worst case environment, Geosynchronous orbit, 100mils of aluminum
2. Temperature = 105°C; V_{DD} and V_{DDQ} = 3.6V

RECOMMENDED OPERATING CONDITIONS

SYMBOL	PARAMETER	LIMITS
V _{DD}	Core supply voltage	2.3V to V _{DDQ}
V _{DDQ}	I/O power supply voltage	2.3V to 3.6V
T _C	Case temperature range	-55°C to +105°C
V _{IN}	DC input voltage	0V to V _{DDQ}
T _J	Junction Temperature	-55°C to +125°C

DC ELECTRICAL CHARACTERISTICS (Pre and Post-Radiation)*

 ($V_{DD} = 2.3V$ to V_{DDQ} , $V_{DDQ} = 2.3$ to $3.6V$; Unless otherwise noted, T_c is per the temperature range ordered)

PARAMETER	DESCRIPTION	CONDITION		MIN	MAX	UNIT
V_{DD}	Core Power Supply Voltage			2.3	V_{DDQ}	V
V_{DDQ}	I/O Power Supply Voltage			2.3	3.6	V
V_{OH}	Output HIGH Voltage	For 3.0V I/O, $I_{OH} = -4mA$		0.8 * V_{DDQ}		V
		For 2.3V I/O, $I_{OH} = -1mA$		2.0		V
V_{OL}	Output LOW Voltage	For 3.0V I/O, $I_{OL} = 8mA$			0.4	V
		For 2.3V I/O, $I_{OL} = 1mA$			0.4	V
V_{IH}	Input HIGH Voltage	For 3.0V I/O		2.0		V
		For 2.3V I/O		1.7		V
V_{IL}	Input LOW Voltage	For 3.0V I/O			0.8	V
		For 2.3V I/O			0.7	V
I_{IN1}	Input Leakage Current	$V_{IN} = V_{DDQ}$ and V_{SS} Except device pins EDACEN, SCRUBEN, TDI, TMS		-2	2	μA
I_{IN2}	Input Leakage Current	$V_{IN} = V_{DDQ}$ Device pins EDACEN, SCRUBEN, TDI, TMS			2	μA
		$V_{IN} = V_{SS}$ Device pins EDACEN, SCRUBEN, TDI, TMS		-100		μA
I_{OZ}	Three-State Output Leakage Current	$V_{DD}, V_{DDQ} = (Max)$, $V_O = V_{DDQ}$ and V_{SS} , $\overline{OE} = V_{DDQ} (Max)$		-2	2	μA
$I_{OS}^{1,2}$	Short-Circuit Output Current	$V_{DD}, V_{DDQ} = (Max)$, $V_O = V_{DDQ}$ and V_{SS}		-100	100	mA
I_{DD}^3	V_{DD} Supply Current in Active Mode	$V_{DD}, V_{DDQ} = (Max)$, $I_{OUT} = 0mA$, $f = f_{max}$	105°C		700	mA
			-55°C and 25°C		600	mA
I_{DDQ}^3	V_{DDQ} Supply Current in Active Mode	$V_{DD}, V_{DDQ} = (Max)$ $I_{OUT} = 0mA$, $f = f_{max}$	105°C		60	mA
			-55°C and 25°C		60	mA
I_{SHTDWN}^3	V_{DD} Supply Current in Shutdown Mode	$V_{DD}, V_{DDQ} = (Max)$, $V_{IN} \geq V_{IH}$ or $V_{IN} \leq V_{IL}$, SHUTDOWN $\geq V_{IH}$	105°C		250	mA
			-55°C and 25°C		200	mA

I_{SHTDWNQ}^3	V _{DDQ} Supply Current in Shutdown Mode	V _{DD} , V _{DDQ} = (Max), V _{IN} ≥ V _{IH} or V _{IN} ≤ V _{IL} , SHUTDOWN ≥ V _{IH}	105°C	15	mA
			-55°C and 25°C	15	mA
I_{STBY}^3	V _{DD} Supply Current in Standby Mode	V _{DD} , V _{DDQ} = (Max) V _{IN} ≥ V _{IH} or V _{IN} ≤ V _{IL} , f = f _{max} , device deselected	105°C	550	mA
			-55°C and 25°C	400	mA
I_{STBYQ}^3	V _{DDQ} Supply Current in Standby Mode	V _{DD} , V _{DDQ} = (Max) V _{IN} ≥ V _{IH} or V _{IN} ≤ V _{IL} , f = f _{max} , device deselected	105°C	60	mA
			-55°C and 25°C	60	mA
I_{ZZ}^3	V _{DD} Supply Current in Sleep Mode	V _{DD} , V _{DDQ} = (Max), V _{IN} ≥ V _{IH} or V _{IN} ≤ V _{IL} , ZZ ≥ V _{IH} , SHUTDOWN ≤ V _{IL}	105°C	500	mA
			-55°C and 25°C	350	mA
I_{ZZQ}^3	V _{DDQ} Supply Current in Sleep Mode	V _{DD} , V _{DDQ} = (Max), V _{IN} ≥ V _{IH} or V _{IN} ≤ V _{IL} , ZZ ≥ V _{IH} , SHUTDOWN ≤ V _{IL}	105°C	55	mA
			-55°C and 25°C	55	mA

CAPACITANCE

SYMBOL	PARAMETER	MIN	MAX	UNIT
C_{IN}^4	Input Capacitance		15	pF
$C_{\text{I/O}}^4$	I/O Capacitance		15	pF

Notes:

* For devices procured with a total ionizing dose tolerance guarantee, the post-irradiation performance is guaranteed at 25°C per MIL-STD-883 Method 1019, Condition A up to the maximum TID level procured.

1. Supplied as a design limit but not guaranteed nor tested.
2. Not more than one output may be shorted at a time for maximum duration of one second.
3. Post-irradiation limits are the 105°C limits when specified.
4. Measured only for initial qualification and after process or design changes that could affect this parameter.

AC CHARACTERISTICS (Pre and Post-Radiation)*

($V_{DD} = 2.3V$ to V_{DDQ} , $V_{DDQ} = 2.3$ to $3.6V$; Unless otherwise noted, T_c is per the temperature range ordered.)¹

PARAMETER	DESCRIPTION	MIN	MAX	UNIT
$t_{Powerup}^2$	V_{DD} to first valid command (READ or WRITE)	100		ms
Clock				
t_{CYC}	Clock (CLK) cycle time	12.5	25.0	ns
t_{CH}	CLK HIGH time	$0.4 * t_{CYC}$	$0.6 * t_{CYC}$	ns
t_{CL}	CLK LOW time	$0.4 * t_{CYC}$	$0.6 * t_{CYC}$	ns
t_r, t_f^2	Input clock rise/fall time (10-90%)	2.25		V/ns
$t_{clkPJ}^{3,5}$	Input clock period jitter	-100	100	ps
$t_{clkCCJ}^{3,5}$	Input clock cycle to cycle jitter		150	ps
Setup Times				
t_{AS}	Address setup time prior to CLK	2.5		ns
t_{DS}	Data setup time prior to CLK	1.5		ns
t_{CENS}	Clock enable (\overline{CEN}) setup time prior to CLK	3		ns
t_{WES}	Write enable (\overline{WE}) setup time prior to CLK	3		ns
$t_{ADV LDS}$	Advance load ($\overline{ADV_LD}$) setup time prior to CLK	2.5		ns
t_{CSS}	Chip select (CS_x) setup time prior to CLK	3		ns
Hold Times				
t_{AH}	Address hold time after CLK	1.2		ns
t_{DH}	Data hold time after CLK	1.4		ns
t_{CENH}	\overline{CEN} hold time after CLK	1.2		ns
t_{WEH}	\overline{WE} hold time after CLK	1.5		ns
$t_{ADV LDH}$	$\overline{ADV_LD}$ hold time after CLK	0.9		ns
t_{CSH}	CS_x hold time after CLK	1.8		ns
Output Times				
t_{CQV}^4	Data valid after rising CLK		12	ns
t_{OEQV}^4	Output enable (\overline{OE}) active to data valid		4.0	ns
t_{CQOH}	Data output hold time after rising CLK	3.0		ns
t_{CQZ}^5	Rising CLK to output three-state time		5.0	ns
t_{CQX}^5	Rising CLK to output enable time	1.3		ns

t_{OEQZ}^5	\overline{OE} inactive to output three-state time		4.5	ns
t_{OEQX}^5	\overline{OE} active to output enable time	0		ns
t_{CMV1}^4	Multiple bit error (MBE0/MBE1) valid after rising CLK		12	ns
t_{CMV2}^4	Multiple bit error (MBEC) valid after rising CLK		13	ns
t_{OEMV1}^4	\overline{OE} active to MBE0/MBE1 valid		4.0	ns
t_{OEMV2}^4	\overline{OE} active to MBEC valid		4.5	ns
t_{CMZ1}^5	Rising CLK to MBE0/MBE1 three-state time		4.5	ns
t_{CMZ2}^5	Rising CLK to MBEC three-state time		4.5	ns
t_{CMX1}^5	Rising CLK to MBE0/MBE1 enable time	1.4		ns
t_{CMX2}^5	Rising CLK to MBEC enable time	1.4		ns
t_{OEMZ1}^5	\overline{OE} inactive to MBE0/MBE1 three-state time		4.5	ns
t_{OEMZ2}^5	\overline{OE} inactive to MBEC three-state time		5.5	ns
t_{OEMX1}^5	\overline{OE} active to MBE0/MBE1 enable time	0		ns
t_{OEMX2}^5	\overline{OE} active to MBEC enable time	0		ns

Notes:

* For devices procured with a total ionizing dose tolerance guarantee, the post-irradiation performance is guaranteed at 25°C per MIL-STD-883 Method 1019, Condition A up to the maximum TID level procured

1. AC Characteristics based on compliance with CLOCK input specifications

2. Supplied as a design guideline, not tested or guaranteed.

3. Period and Cycle to Cycle jitter is defined by JEDEC Standard 65B

4. Maximum data output valid times guaranteed up to 25pf load capacitance. For loads >25pf, a derating factor of parameter = [specification max(ns) + (C_{Load} - 25pF)(44.2ps/pF)].

5. Guaranteed by design.

SHUTDOWN AND SLEEP MODE CHARACTERISTICS (Pre and Post-Radiation)*(V_{DD} = 2.3V to V_{DDQ}, V_{DDQ} = 2.3 to 3.6V; Unless otherwise noted T_C is for temperature range ordered.)

PARAMETER	DESCRIPTION	CONDITION	MIN	MAX	UNIT
t _{ZZS} ³	Device operation to SLEEP mode	ZZ ≥ V _{IH}	1 t _{CYC}		ns
t _{ZZH} ³	SLEEP high pulse width	ZZ ≥ V _{IH}	100		μs
t _{ZZL} ³	SLEEP low pulse width	ZZ ≤ V _{IH}	100		μs
t _{SHTDWN} ³	Device operation to SHUTDOWN	SHUTDOWN ≥ V _{IH}	2 t _{CYC}		ns
t _{ZZREC} ³	SLEEP recovery time	STANDBY ≤ V _{IL}	100 + (3*t _{CYC})		ns
t _{SHTDWNREC} ^{1,3}	SHUTDOWN recovery time	SHUTDOWN ≤ V _{IL}		50	μs
t _{ZZI} ⁴	Active to SLEEP current	ZZ ≥ V _{IH}		100 + (3*t _{CYC})	ns
t _{SHTDWN} ⁴	Active to SHUTDOWN current	SHUTDOWN ≥ V _{IH}		250	ns
t _{RZZI} ⁴	Time to exit SLEEP current mode	STANDBY ≤ V _{IL} Notes	0		ns
t _{RSHTDWN} ⁴	Time to exit SHUTDOWN current mode	SHUTDOWN ≤ V _{IL}	0		ns
t _{CR} ^{1,2,3}	Clock recovery prior to exiting ZZ	ZZ ≥ V _{IH}		20	μs
t _{RLRH}	$\overline{\text{RESET}}$ low to high time	Shutdown ≤ V _{IL}	1		μs
t _{PDS} ³	SLEEP setup time prior to CLK		2.0		ns
t _{PDH} ³	SLEEP hold time after CLK		0.5		ns

Notes:

* For devices procured with a total ionizing dose tolerance guarantee, the post-irradiation performance is guaranteed at 25°C per MIL-STD-883 Method 1019, Condition A up to the maximum TID level procured

1. The clock must start up prior to exiting sleep or shutdown modes. Parameter is guaranteed by design.
2. T_{CR} is necessary anytime the clock is stopped, after initial power on, or exiting shutdown mode.
3. Tested functionally.
4. Guaranteed by design.

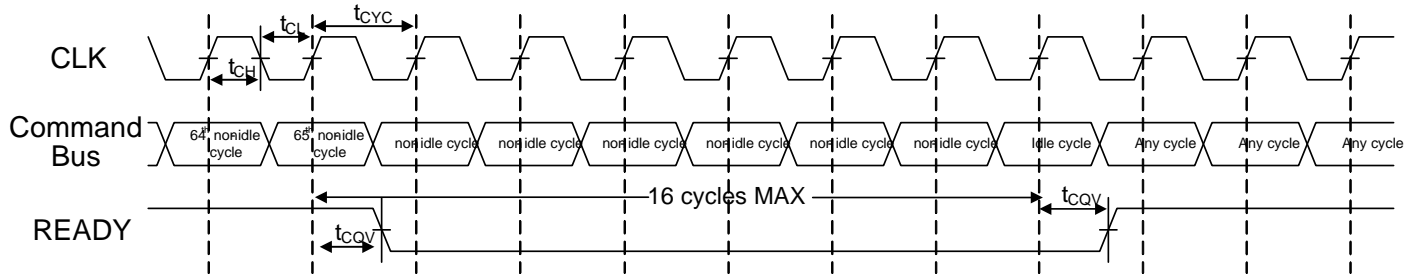

Figure 3. Switching Waveform for Internal Housekeeping

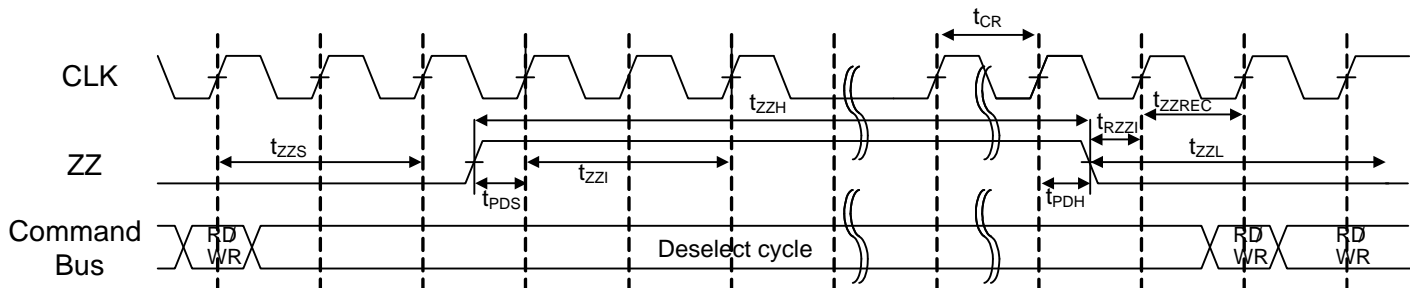

Figure 4. Switching Waveform for SLEEP Mode

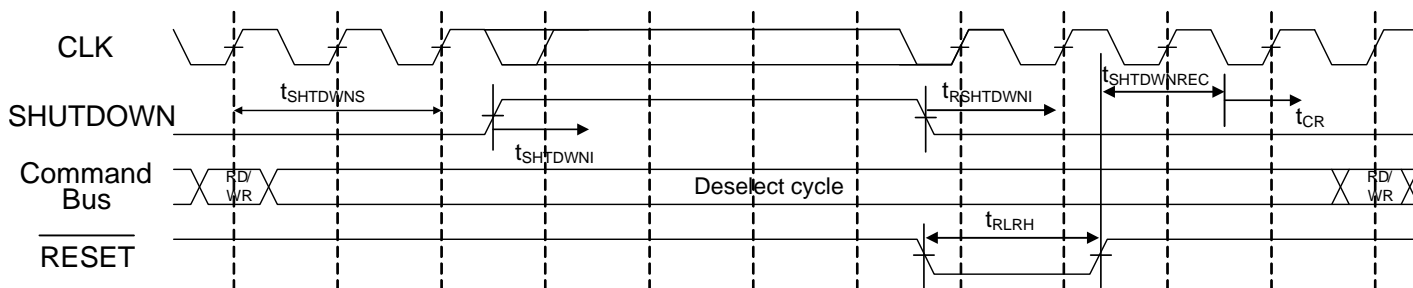

Figure 5. Switching Waveform for SHUTDOWN Mode

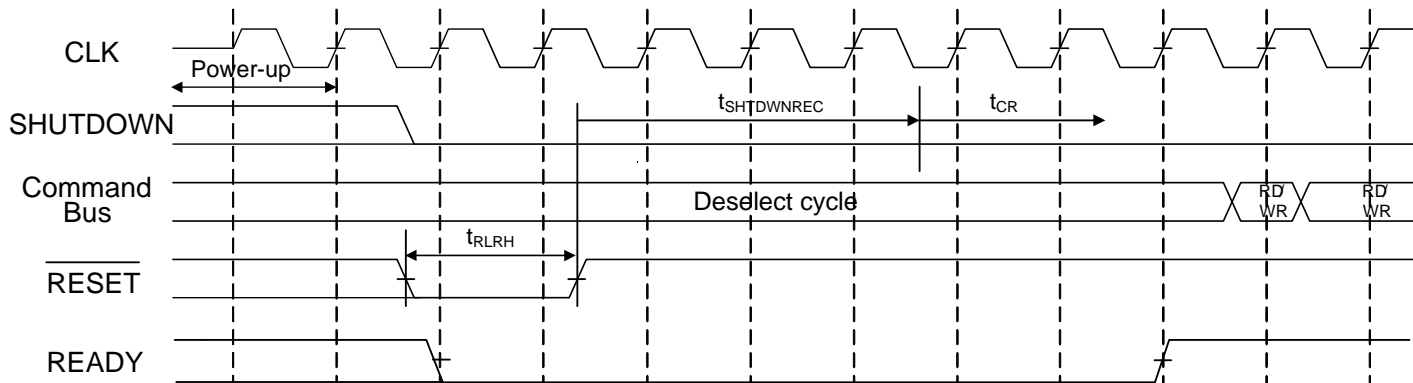
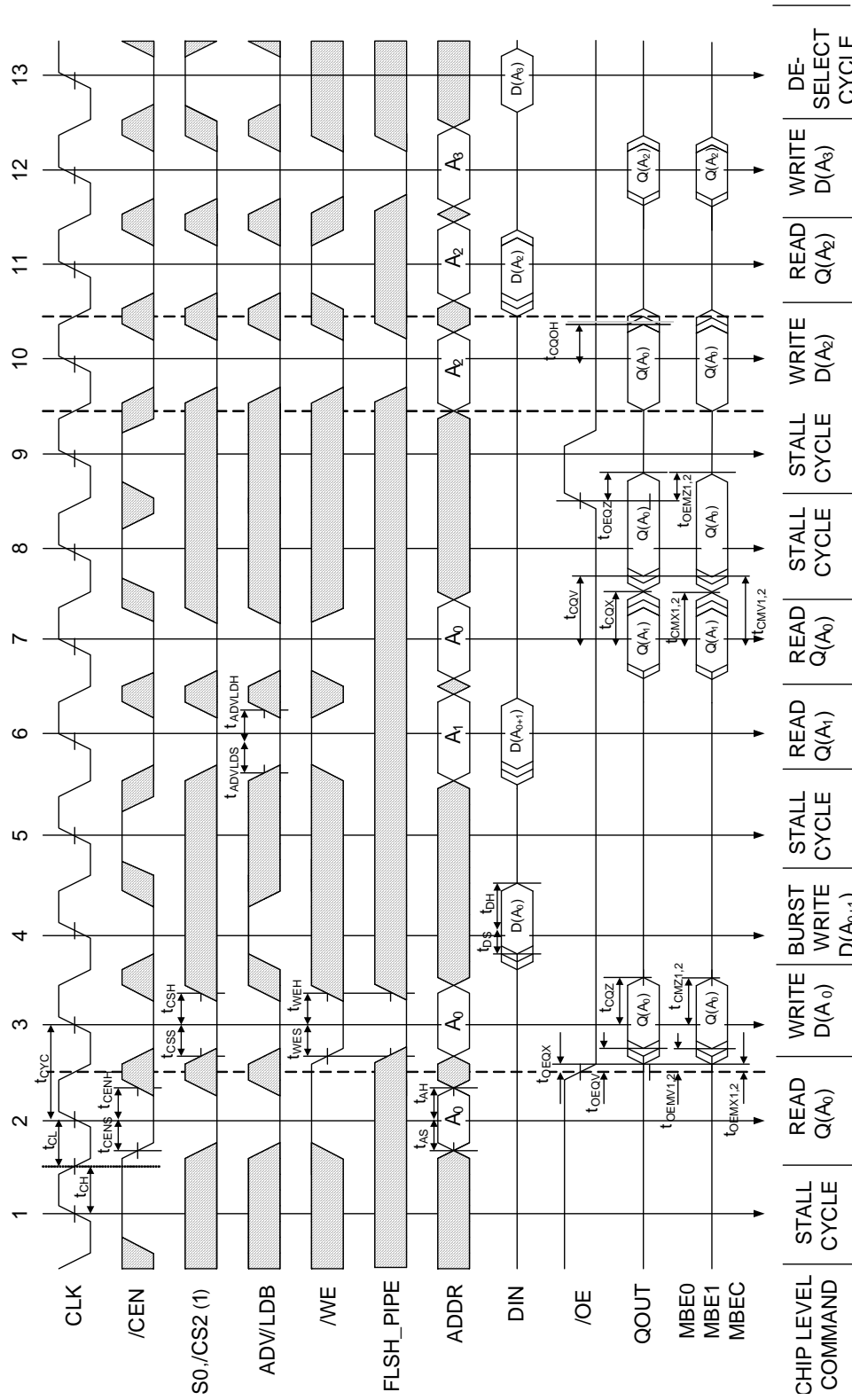

Figure 6. Switching Waveform for Power-Up



Notes:

1. CS1 has timing transitions identical to /CS0 and /CS2 but is inverted logically. For example, when /CS0 and /CS2 are LOW CS1 is HIGH.

Figure 7. Switching Waveforms for Flow-thru Cycle Operations

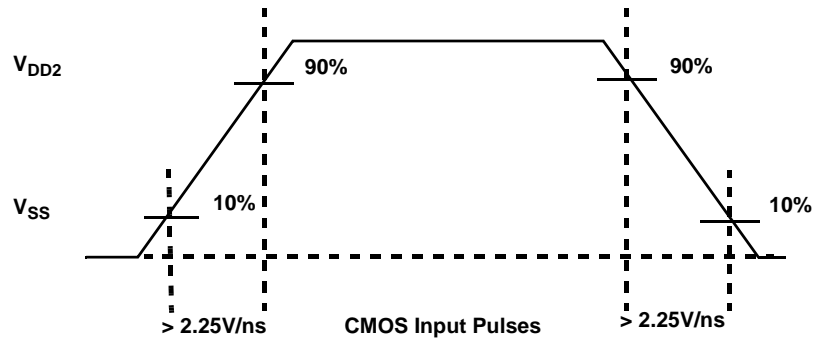
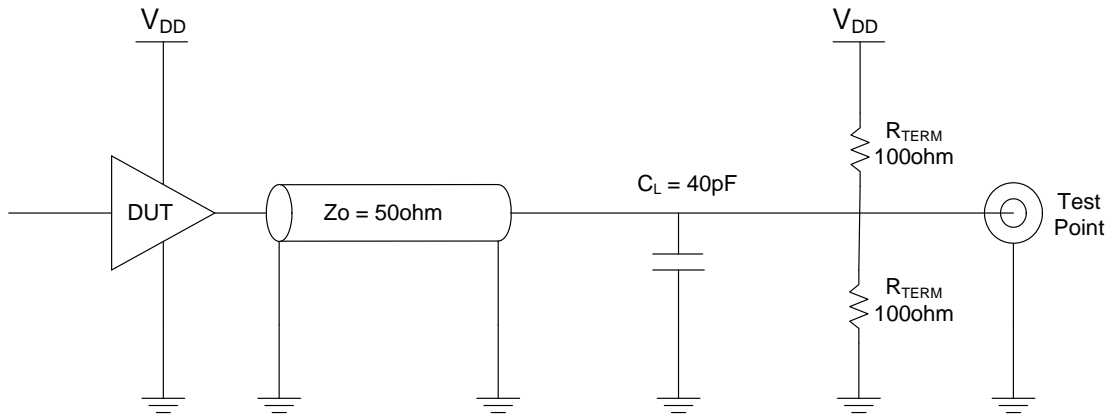

Notes:

1. Measurement of data output occurs at the low to high or high to low transition mid-point (i.e., CMOS input = $V_{\text{DD}2}/2$)

Figure 8. AC Test Loads and Input Waveforms

PACKAGING

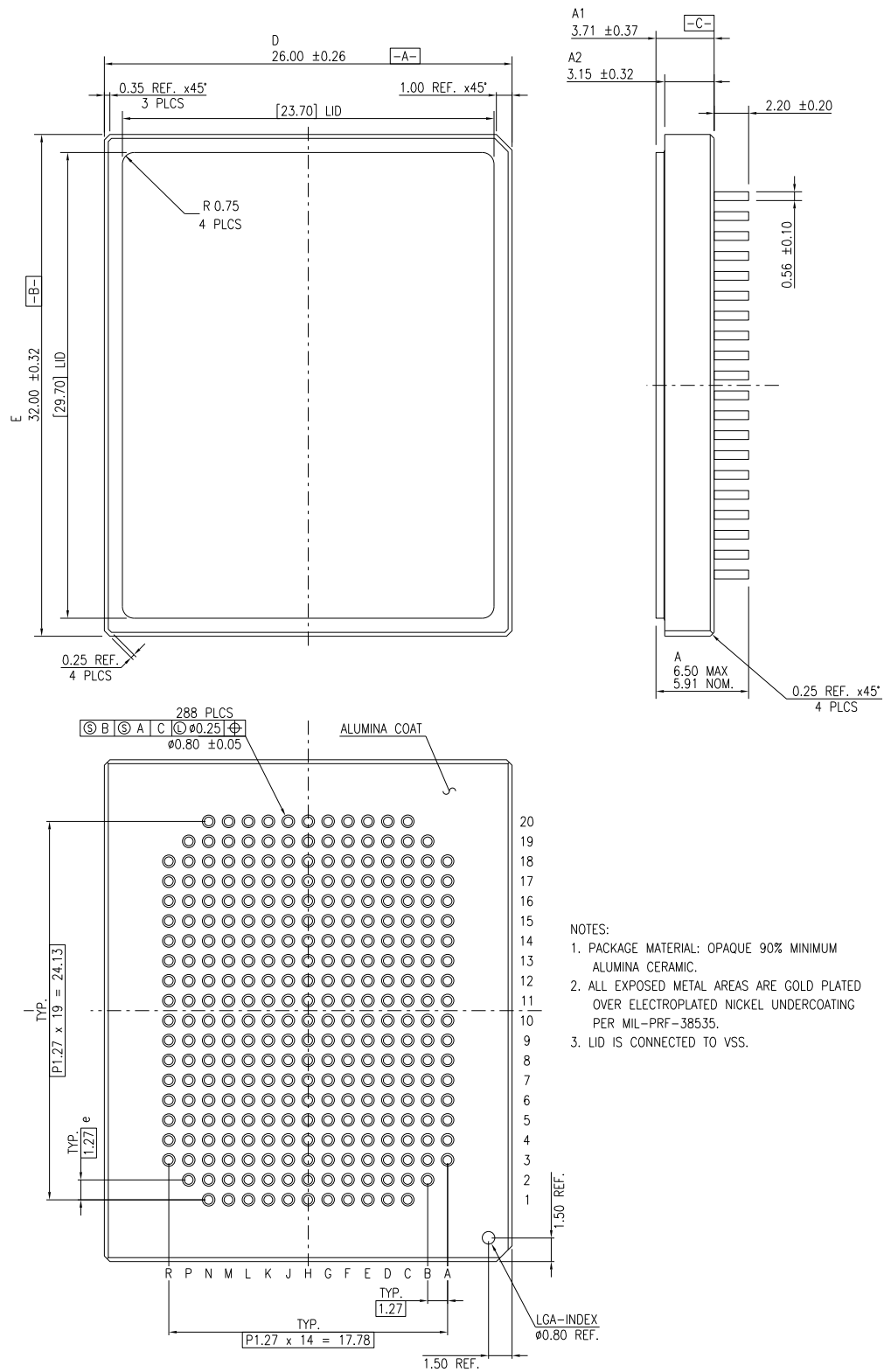

Figure 9. 288-Lead CCGA

PACKAGING

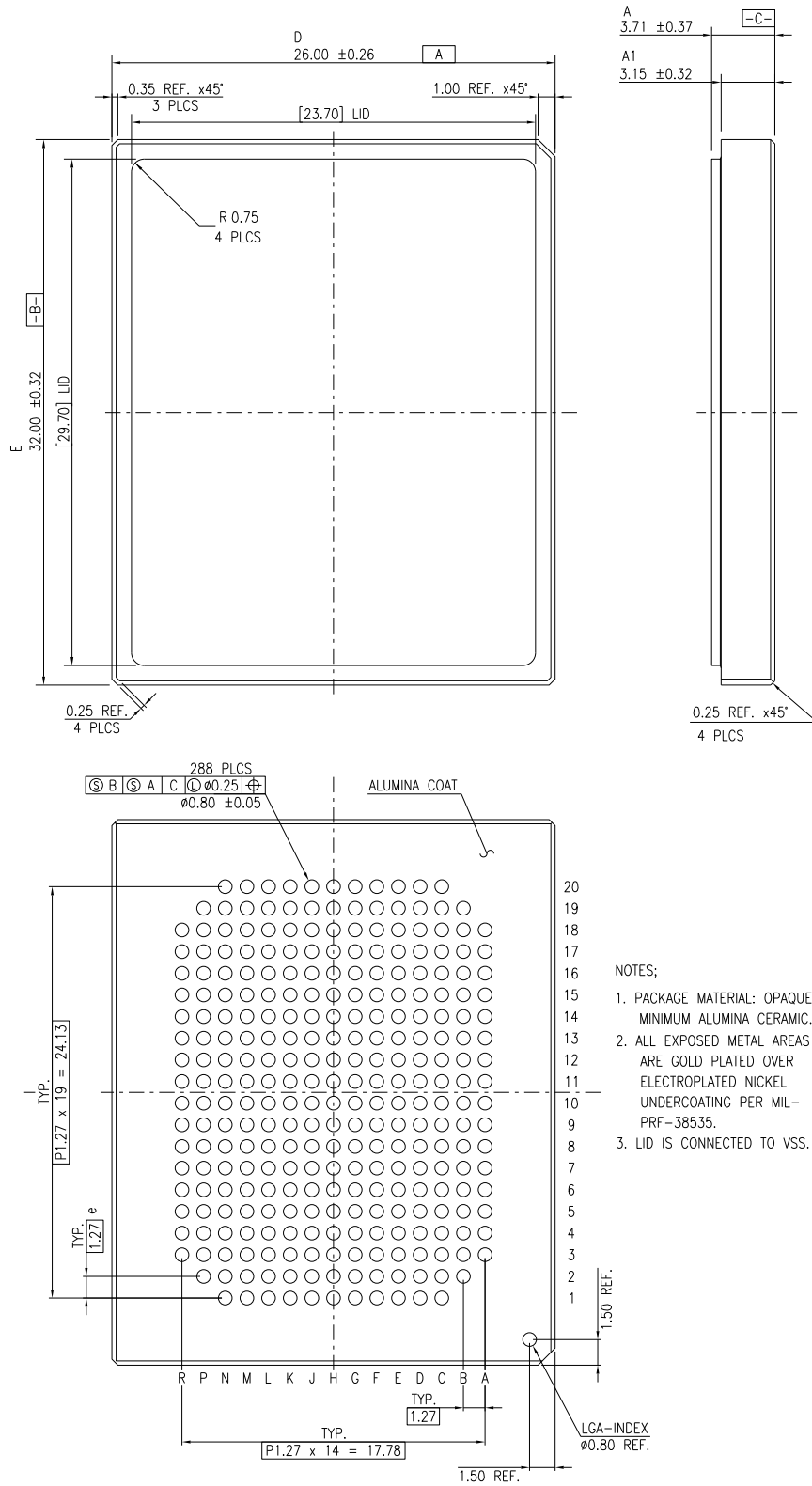

Figure 10. 288-Lead CLGA

PACKAGING

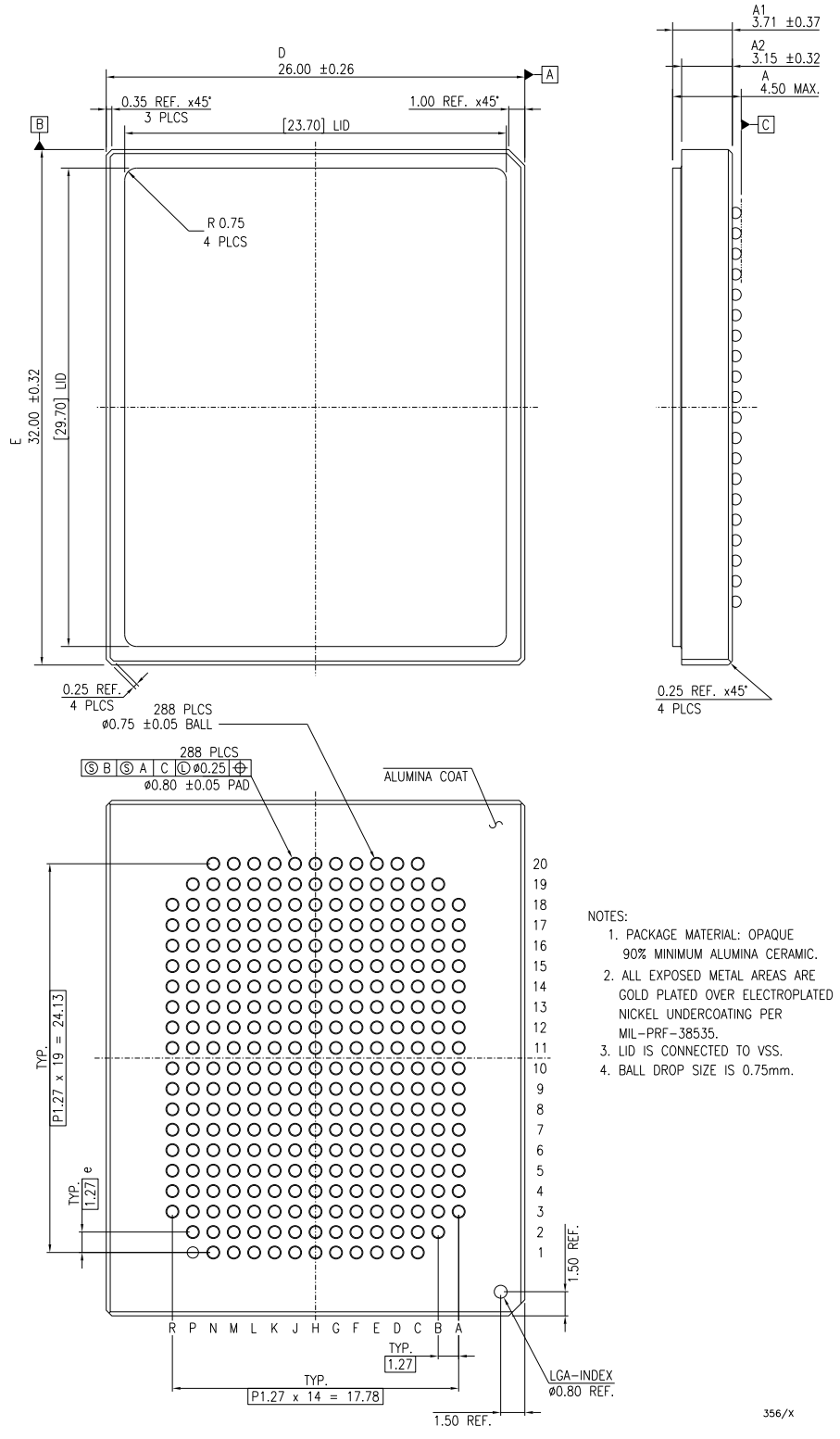
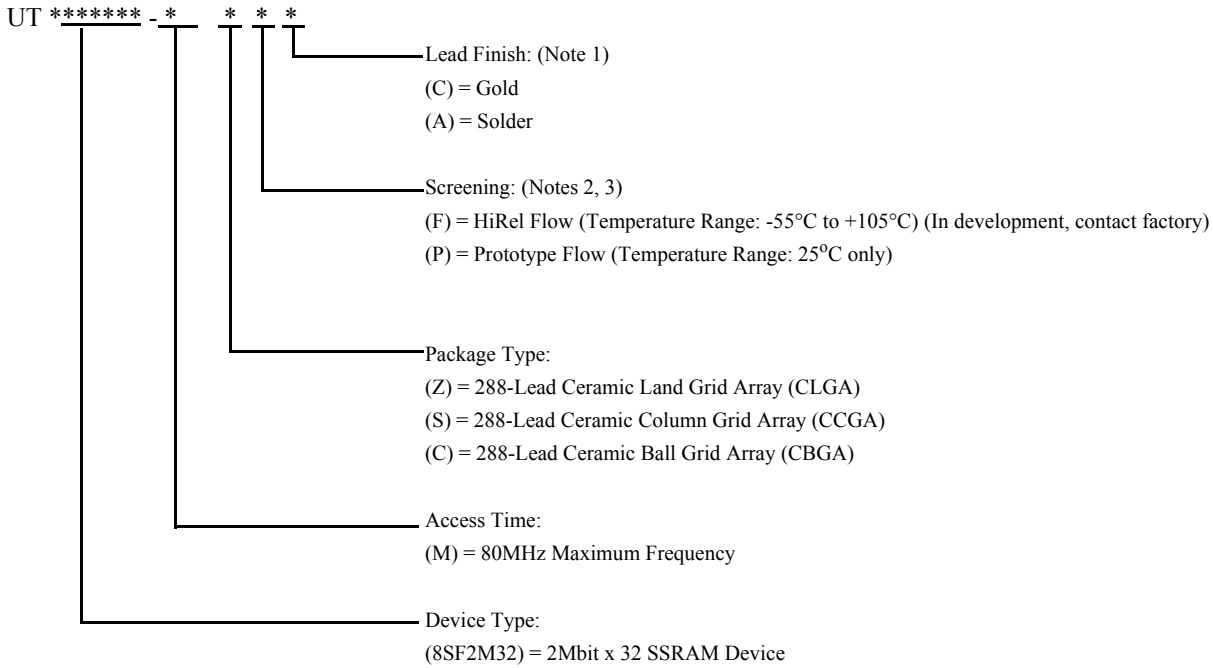

Figure 11. Advanced 288-lead CBGA, ball dimensions (A, A1, A2) are subject to change

ORDERING INFORMATION

2M x 32 SSRAM



Notes:

1. Lead finish per the table below.
2. Prototype Flow per Aeroflex Manufacturing Flows Document. Devices are tested at 25°C only. Radiation is neither tested nor guaranteed.
3. HiRel flow per Aeroflex Manufacturing Flows Document. Radiation is neither tested nor guaranteed.

Package Option	Associated Lead Finish Option
(Z) 288-CLGA	(C) Gold
(S) 288-CCGA	(A) Hot Solder Dipped
(C) 288-CBGA	(A) Hot Solder Dipped

2M x 32 SSRAM: SMD

5962 * ***** ** * * *

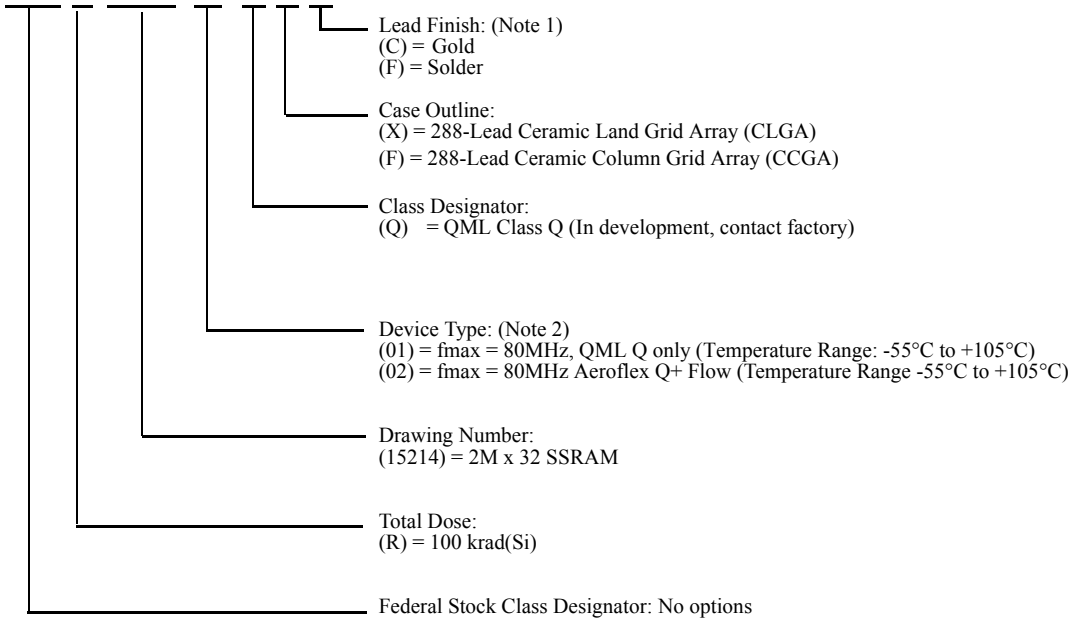

Notes:

1. Lead finish per the table below.
2. Aeroflex's Q+ assembly flow, as defined in section 4.2.2.d of the SMD, provides QML-Q product through the SMD that is manufactured with Aeroflex's QML-V flow.

Package Option	Associated Lead Finish Option
(X) 288-CLGA	(C) Gold
(F) 288-CCGA	(F) Hot Solder Dipped

Aeroflex Colorado Springs - Datasheet Definition

Advanced Datasheet - Product In Development

Preliminary Datasheet - Shipping Prototype

Datasheet - Shipping QML & Reduced Hi-Rel

This product is controlled for export under the U.S. Department of Commerce (DoC). A license may be required prior to the export of this product from the United States.

www.aeroflex.com/HiRel info-ams@eroflex.com



Aeroflex Colorado Springs, Inc., reserves the right to make changes to any products and services described herein at any time without notice. Consult Aeroflex or an authorized sales representative to verify that the information in this data sheet is current before using this product. Aeroflex does not assume any responsibility or liability arising out of the application or use of any product or service described herein, except as expressly agreed to in writing by Aeroflex; nor does the purchase, lease, or use of a product or service from Aeroflex convey a license under any patent rights, copyrights, trademark rights, or any other of the intellectual rights of Aeroflex or of third parties.



Our passion for performance is defined by three attributes represented by these three icons: solution-minded, performance-driven and customer-focused

DATA SHEET REVISION HISTORY

Revision Date	Description of Change	Page(s)	Author
9/16/13	Release of Preliminary Data Sheet	All	MJL
10/1/13	Page 3: DQ[51:0] added Aeroflex pull-up/down recommendation Page 8: Table 4 revised Page 9: Corrected CSx state for Sleep Mode from X to H	As noted	MJL
11/4/13	Page 3: Added manual RESET pin to Table 1. Page 10: Pull-up/down requirements changed from 75kΩ to 10kΩ R17 bias from V _{SSQ} to V _{DDQ} P16 from V _{SSQ} to NUIH P11 bias from V _{SS} to V _{DDQ} P6 from NUIL to V _{SSQ} R11 from V _{DDQ} to RESET Page 16: Shutdown and Sleep Mode Characterization table revised: t _{SHTDWNREC} corrected from 100ms max to 50us min t _{CR} corrected from 10us to 20us max Page 17: Corrected Figures 4-6	As noted	MJL
1/10/14	Page 8: Added SSRAM requires V _{DD} ≤ V _{DDQ} . Clarified clock conditioning paragraph. Page 12, 14, 16: Added V _{DDQ} voltage range to top of tables. Page 12: Changed IDDQ specification for all modes. Adjusted current specifications. Page 13: Added Note 3 for 105°C post-irradiation specifications. Page 15: Changed Note 5 to guaranteed by design and added note reference to all X and Z specifications. Page 23, 24: Corrected pin count for CLGA to 288 and corrected package designators to (Z) (S).	As noted	MJL
1/23/14	Page 1: Edits to Features bullets 2,3,5 and 13	As noted	MJL
4/24/14	Page 1: SEU changed to 1x10 ⁻¹⁵ Page 6, 7: Multiple wording typo corrections Page 11: Θ _{JC} changed to 3°C/W Page 13: CIN and CI/O change to 15pF. Page 14,1 5: Standardized signal names in descriptions and added note numbers to some parameters. Reworded note 4. Page 16: Added notes 3 and 4. Page 17: Added SHUTDOWN to signal in Figure 5. Page 22: Added advanced to Figure 11 title.	As noted	MJL
8/19/14	Page 12: Added IDDQ parameters for Stby, Shutdown, and Sleep modes. Finalized all current limits per characterization data. Page 14, 15: Finalized AC Setup, Hold, and Output limits per characterization data.	As noted	MJL

10/2/2014	<p>Page 11: Added Operational Environment table.</p> <p>Page 12: Added I_{IN} paramter for EDACEN, TDI, and TMS pins. DC ELECTRICAL CHARACTERISTICS table</p> <p>Page 16: Corrected min t_{CYC} in Shutdown and Sleep Mode Characteristics table</p> <p>Page 23 and 24: Updated SMD and Ordering Info sections.</p>	As noted	MJL
3/18/2015 Ver. 1.8.0	<p>Page 1: Clock-to-ouput time changed from 11.5ns to 12ns. Added SMD Designator.</p> <p>Page 8: Added pinout R7 and R8 to Table 4.</p> <p>Page 10: Changed pinout R7 and R8 from VSS to NUIL</p> <p>Page 11: Changed P_D from 10 W to 15 W</p> <p>Page 12: SCRUBEN Device Pin added to Condition column of parameters I_{IN1} and I_{IN2} in the DC ELECTRICAL CHARACTERISTICS table</p> <p>Page 14: The minimum setup times for parameters t_{CENS}, t_{WES}, and t_{CSS} have changed from 2.5ns to 3ns, and the maximum output time for t_{CQV} and t_{CMV1} changed from 11.5ns to 12ns and t_{CMV2} changed from 12.5ns to 13ns in the AC ELECTRICAL CHARACTERISTICS table.</p> <p>Page 16: Minimum number of t_{CYC} changed from 1 t_{CYC} to 2 t_{CYC} for t_{SHTDWS} parameter in the SHUTDOWN AND SLEEP MODE CHARACTERISTICS TABLE</p> <p>Pages 20 and 21: Corrected bottom view orientation of package diagram.</p> <p>Page 24: A correction the Lead Finish section of the SMD ordering encoder page. The Solder lead finish designator was changed from "A" to "F". Added SMD designator</p>		
April 2015 Ver. 1.9.4	<p>Page 8: Added pinout R13, R14, and R16 to Table 4.</p> <p>Page 10: Changed pinout R13, R14, and R16 from VSS to NUIL, and P8 from VSS to VSSQ</p>		